

6-SERIES

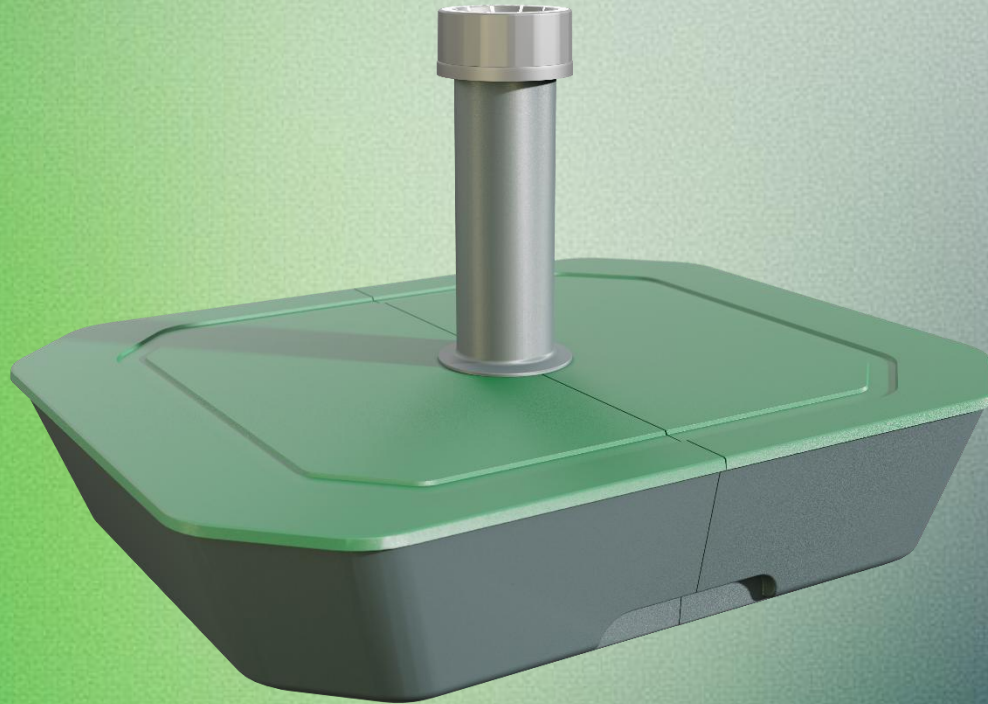

the bases factory



INHOUD



01 Recycling

02 Overzicht

03 Buizen

04 Gewicht

05 Kleur

06 Verpakking

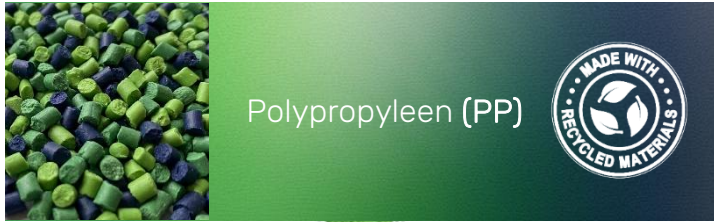



Overzicht

- Compact
- Grote aantallen op pallet
- Duurzaam product
- Makkelijk te monteren
- Zand en water vulbaar
- Diverse versies en kleuren



03 Buizen



L 500 B 400 H 100 mm
Totale hoogte: 354 mm

38 mm

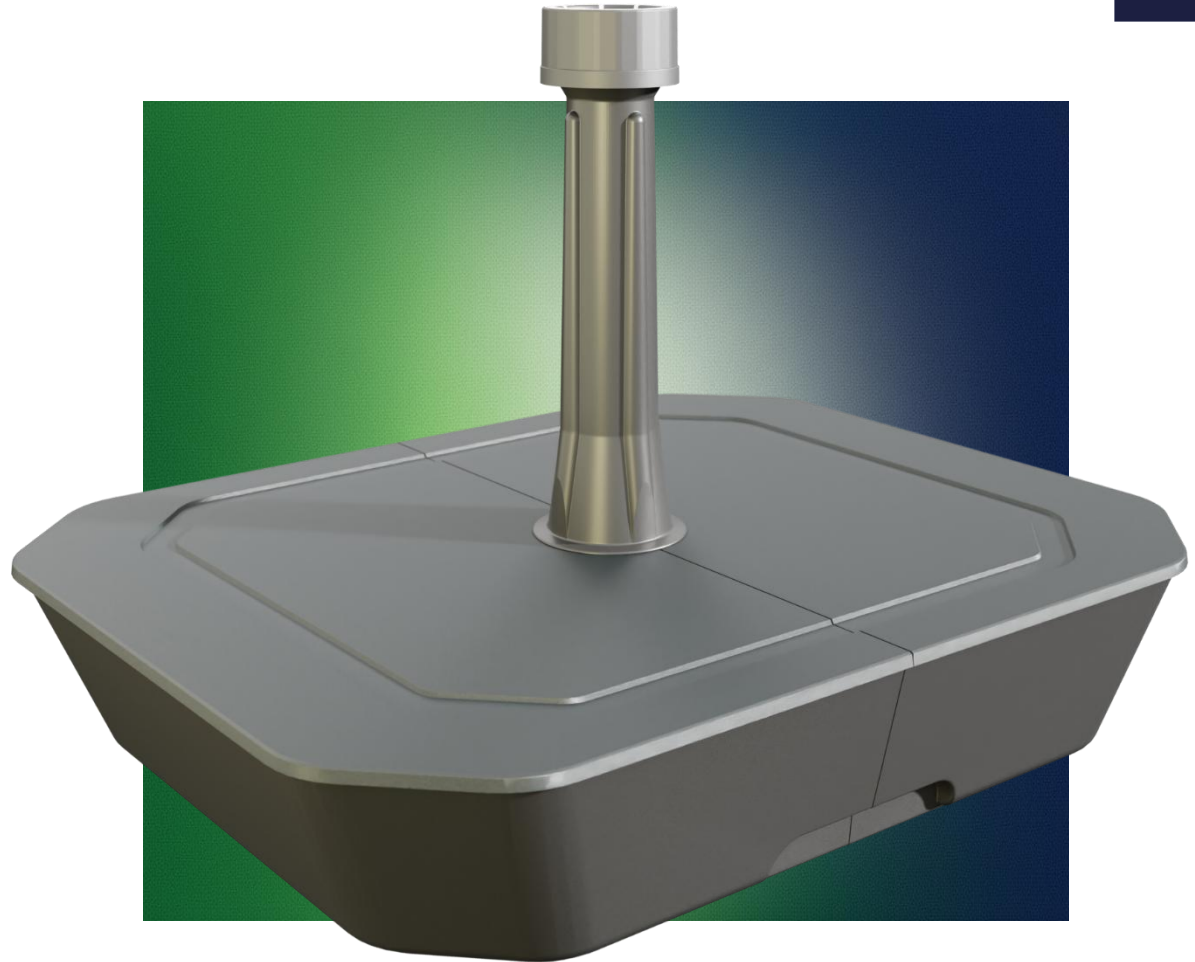

Materiaal: Polypropyleen (PP)

 **Ø 19-38 mm – Max. 3 m**



L 500 B 400 H 100 mm
Totale hoogte: 319 mm

54 mm

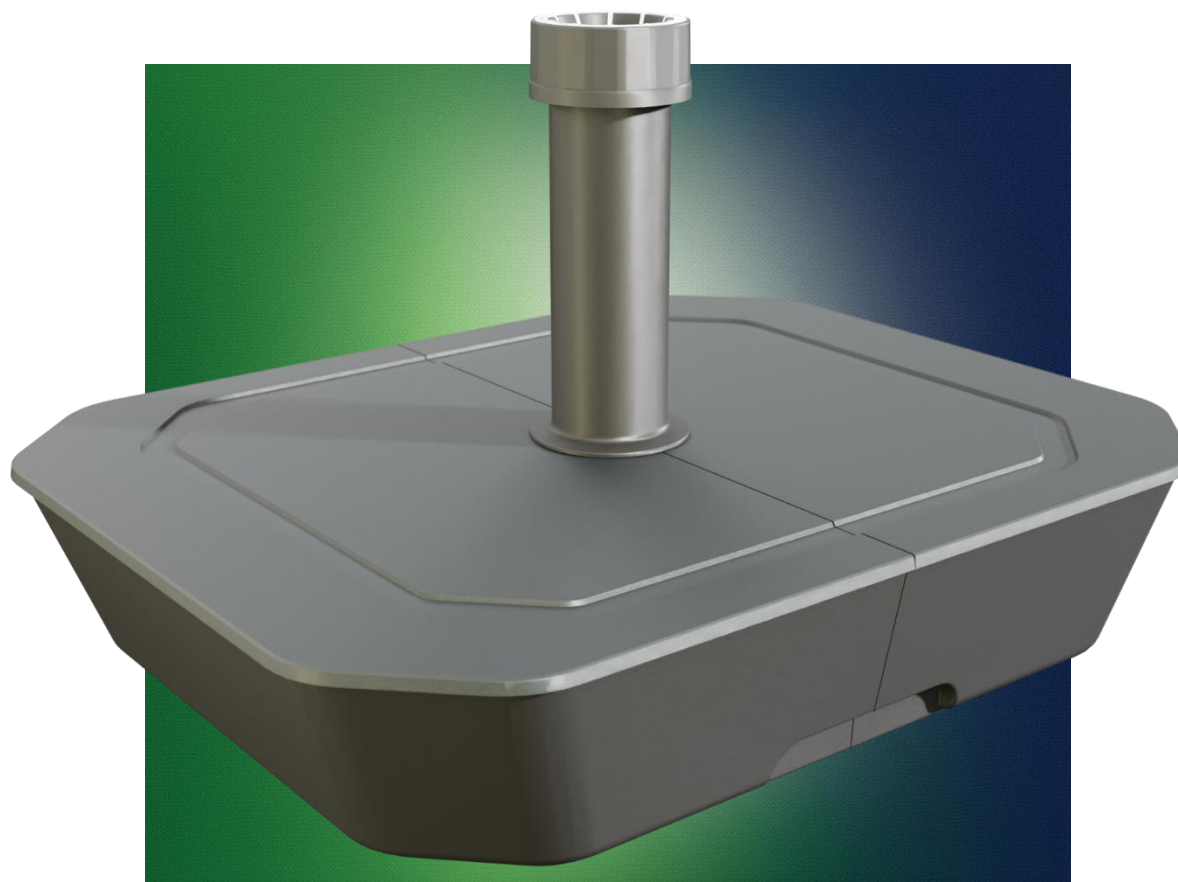

Materiaal: Polypropyleen (PP)

 **Ø 21-54 mm – Max. 3 m**

03 Buizen

Supergrip

Reductor 38 mm

Buis 38 mm

Deksel

Bak

Schroeftoren

38 mm



54 mm

Supergrip

Reductor 54 mm

Buis 54 mm

Deksel

Bak

Schroeftoren

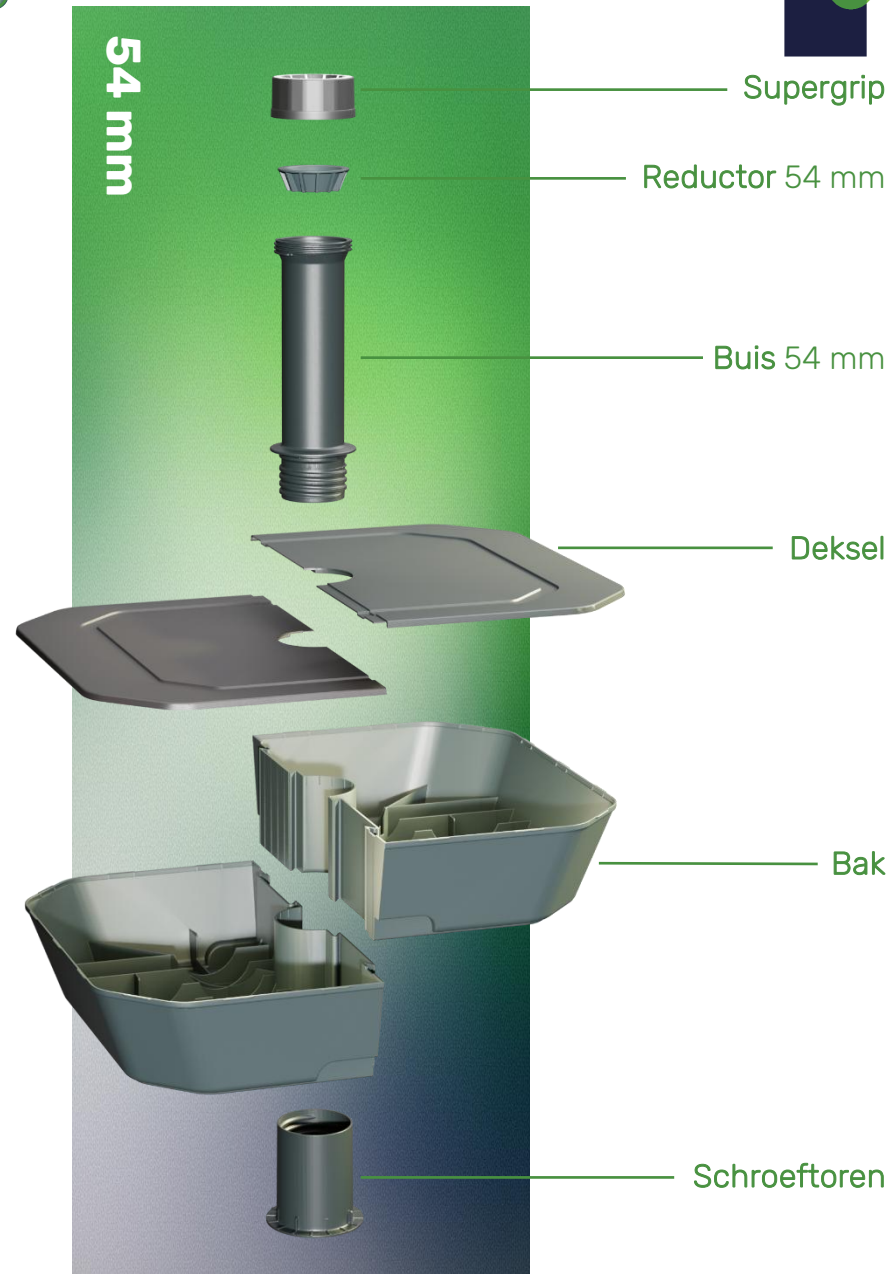

04 Gewicht

Water
tot 15 kg

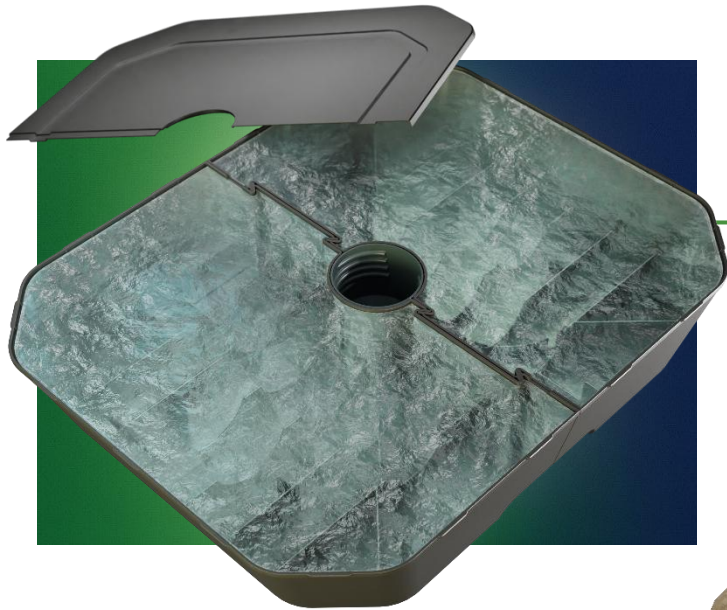

Water en zand
tot 25 kg

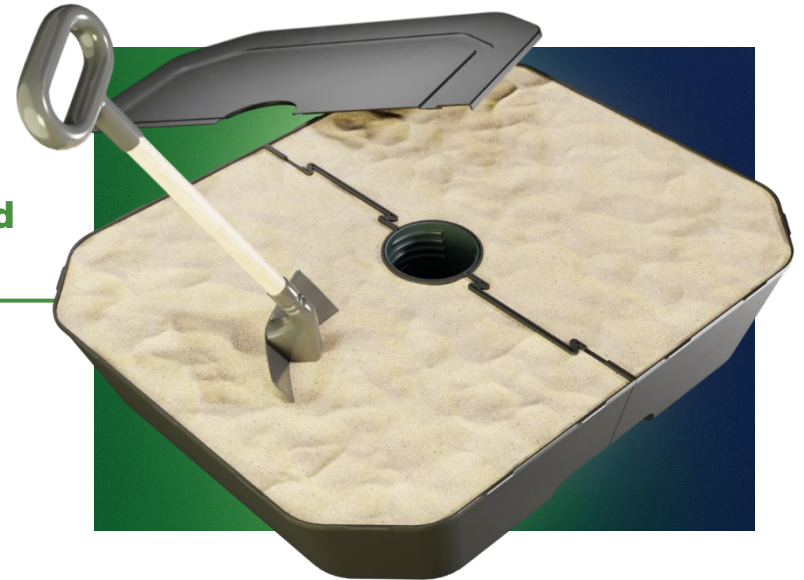

Water, zand en grind
tot 30 kg

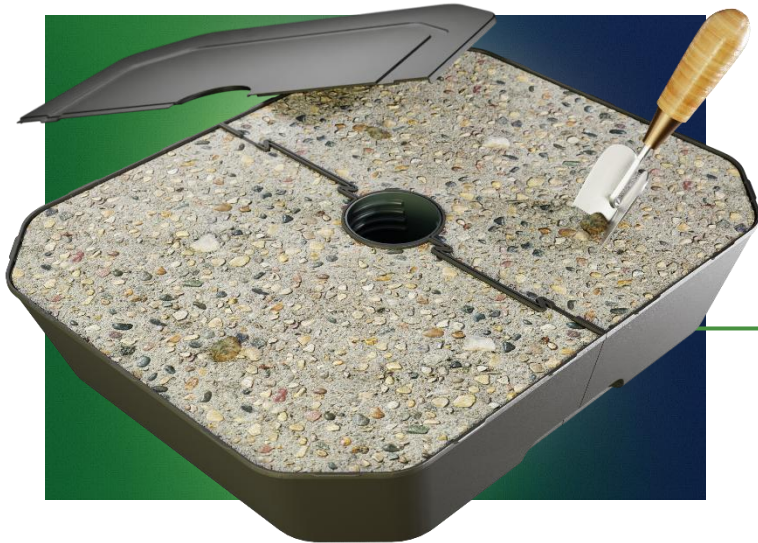





38 mm

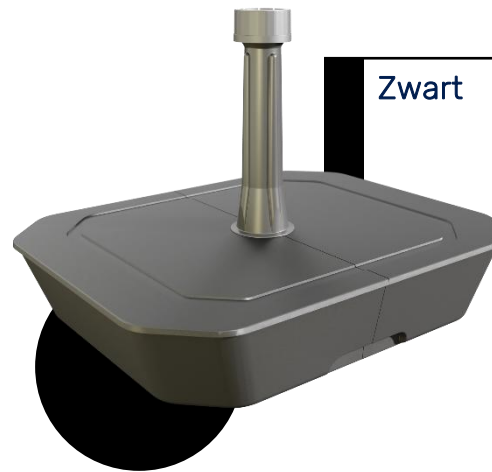
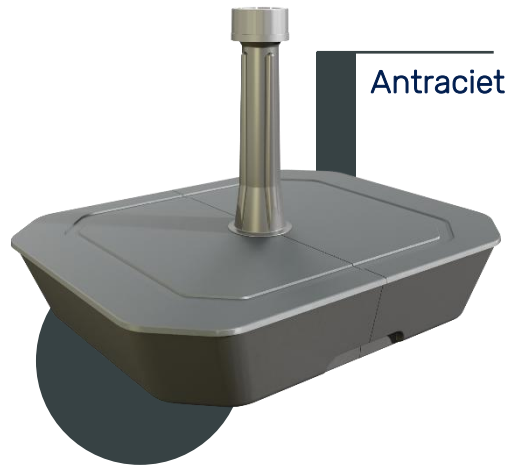

54 mm





DOOS

Europallet

Max. hoogte 1,80 m (incl. pallet): 90 stuks

Afmetingen verpakking

40,3 x 28 x 15,5 cm

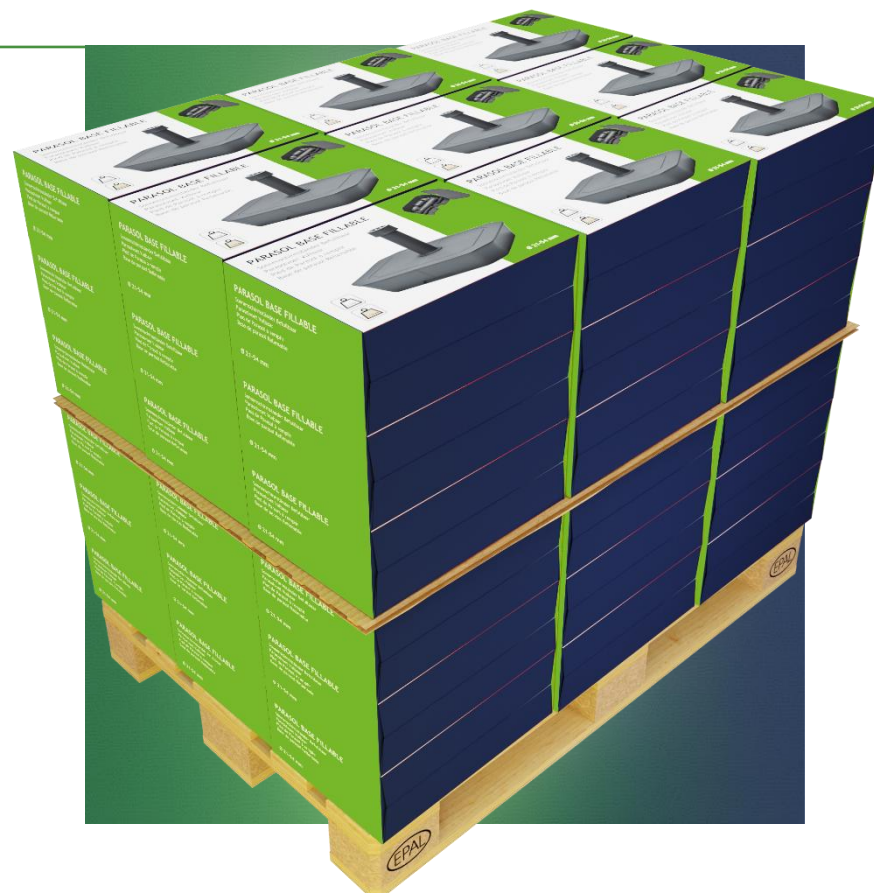



6-SERIES

the bases factory